

Input

Ground

Output

Ground

Company: Sjöström Audio		
Product no: SSB-01	Customer: Sjöström Audio	
Title Sjöström Super Buffer Ultra High Performance Diamond Buffer		
Design: P-A	Drawing: P-A	Approved: P-A
Size: A3	Revision: 0	Created: 2009-03-13
Sheet 1 of 1	Changed: 2009-04-06	Printed: 2009-04-06
File: ssb01r0.SchDoc		

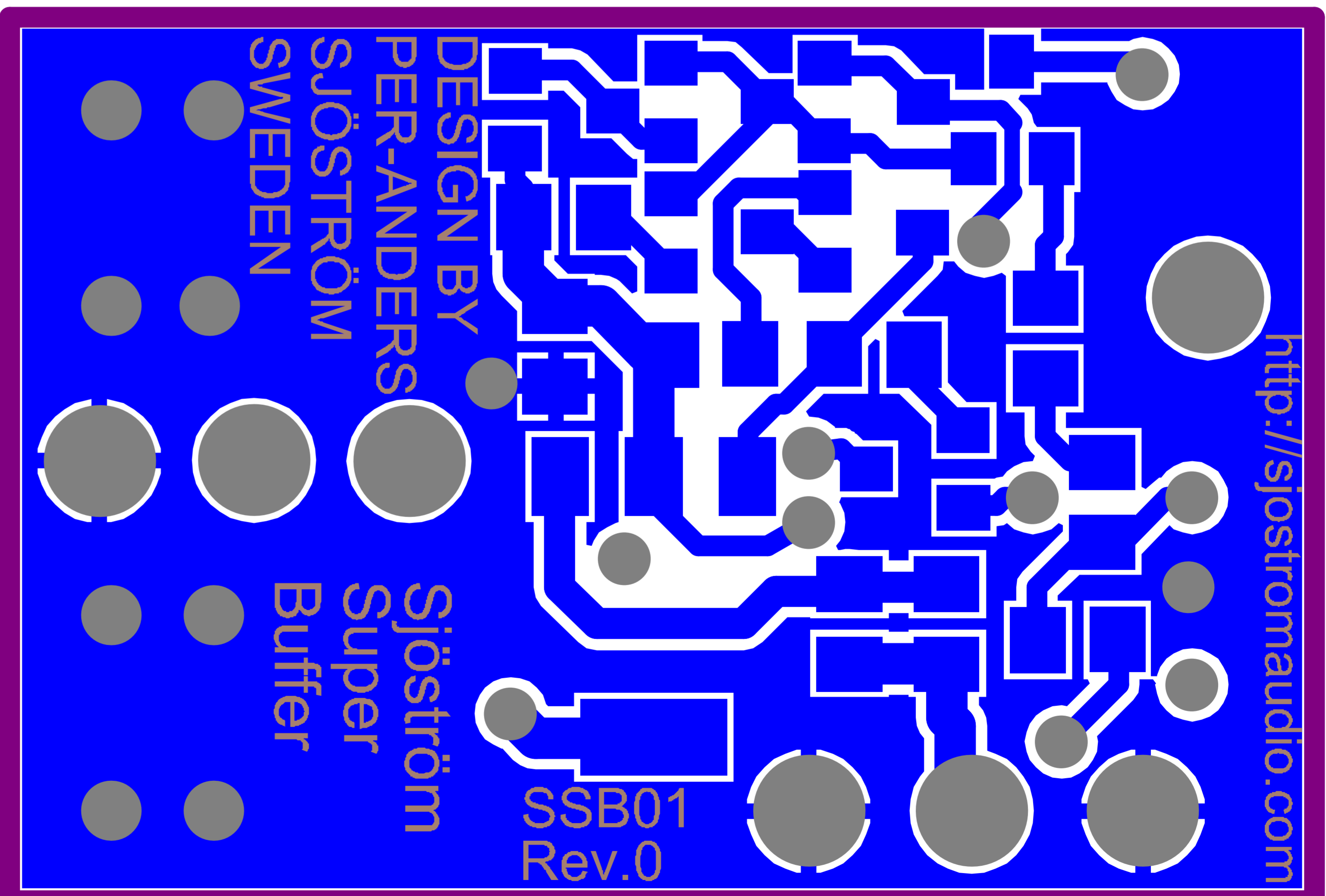

0 BOT LAYER

0 BOT SOLDER

22B01 Rev.0
PCB BORDER OF

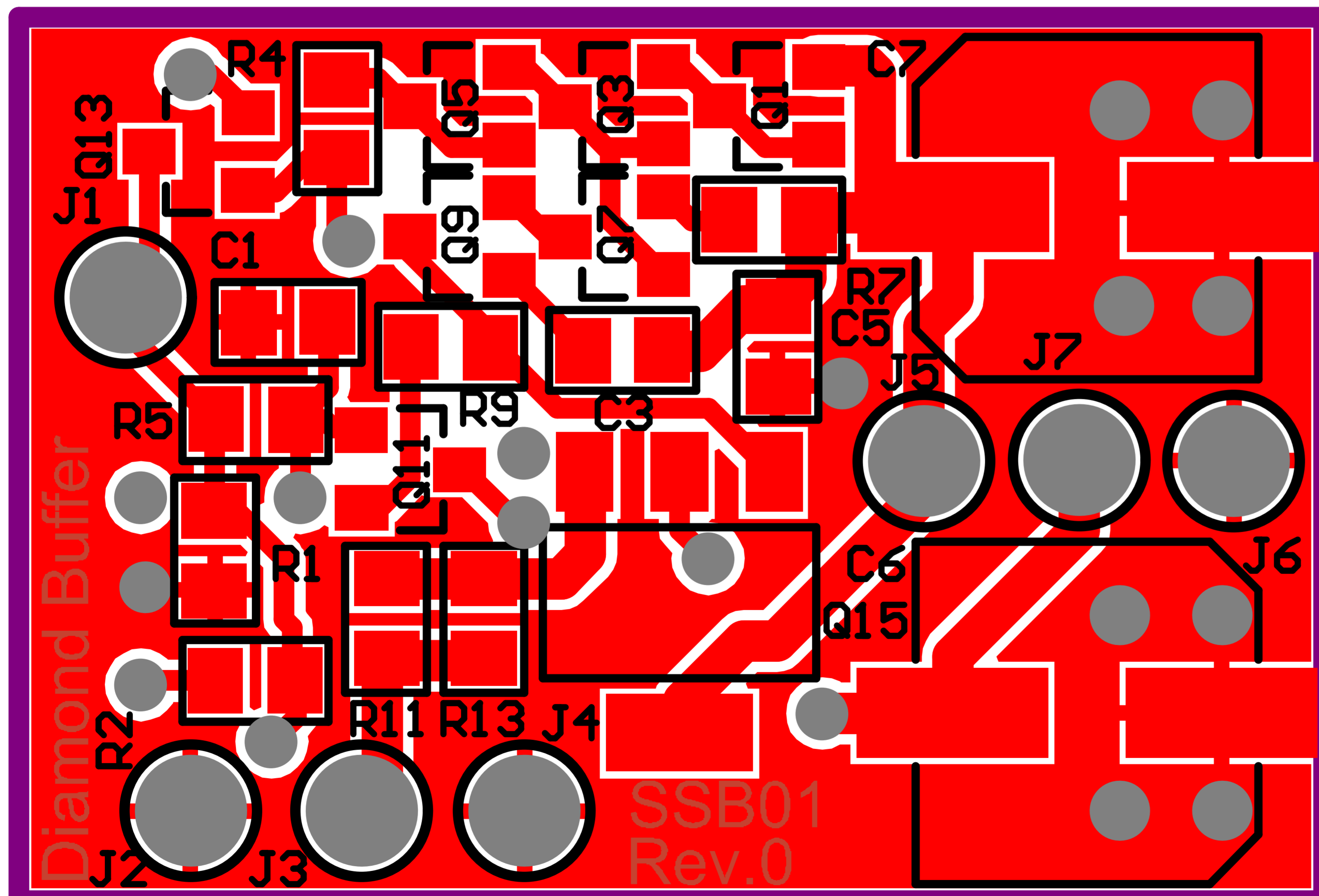

TOP LAYER SS

TOP SOLDER SS

TOP OVERLAY SS

PCB BORDER OL

SSB01 Rev.0

TOP LAYER SS

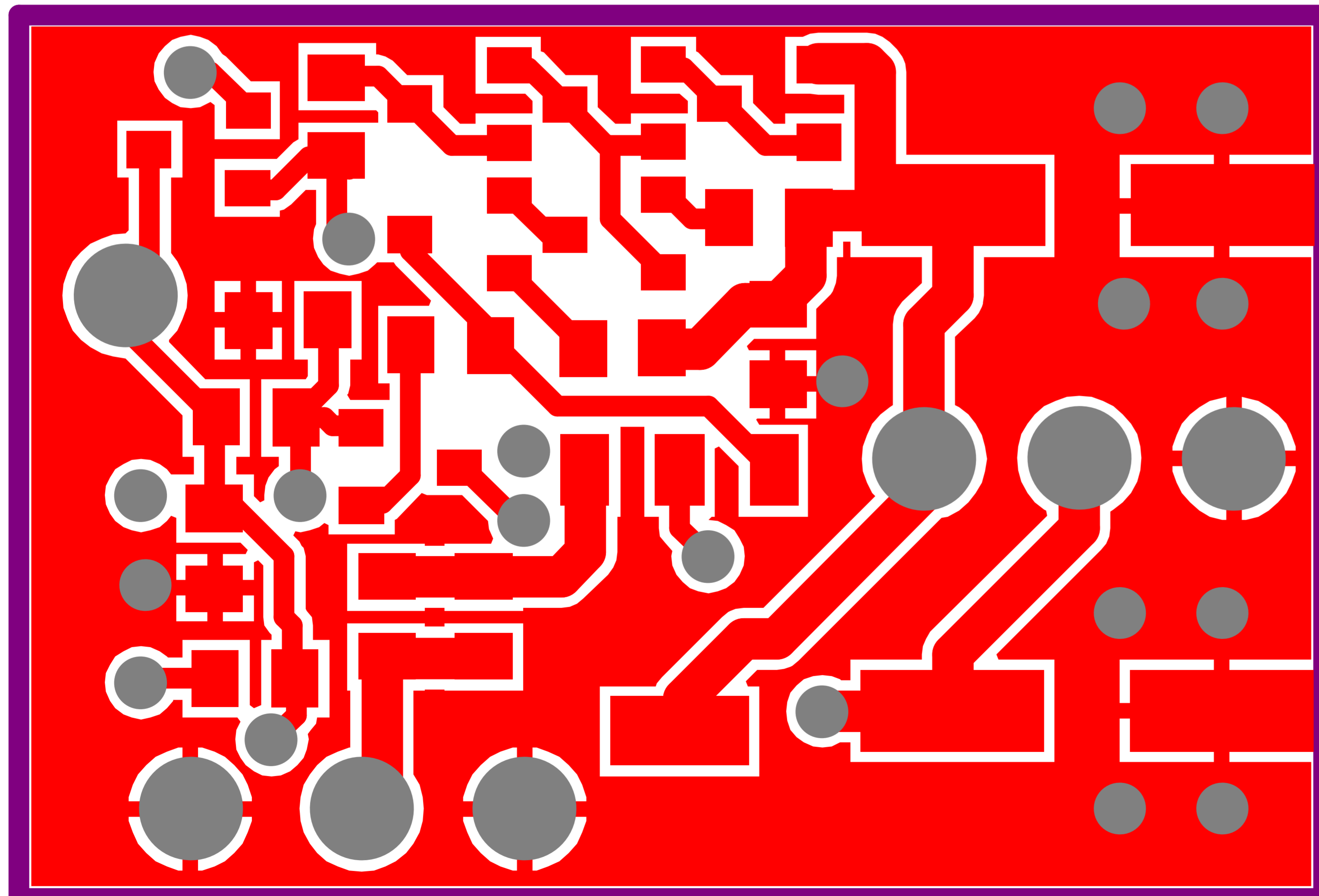

PCB BORDER OL
SSB01 Rev.0

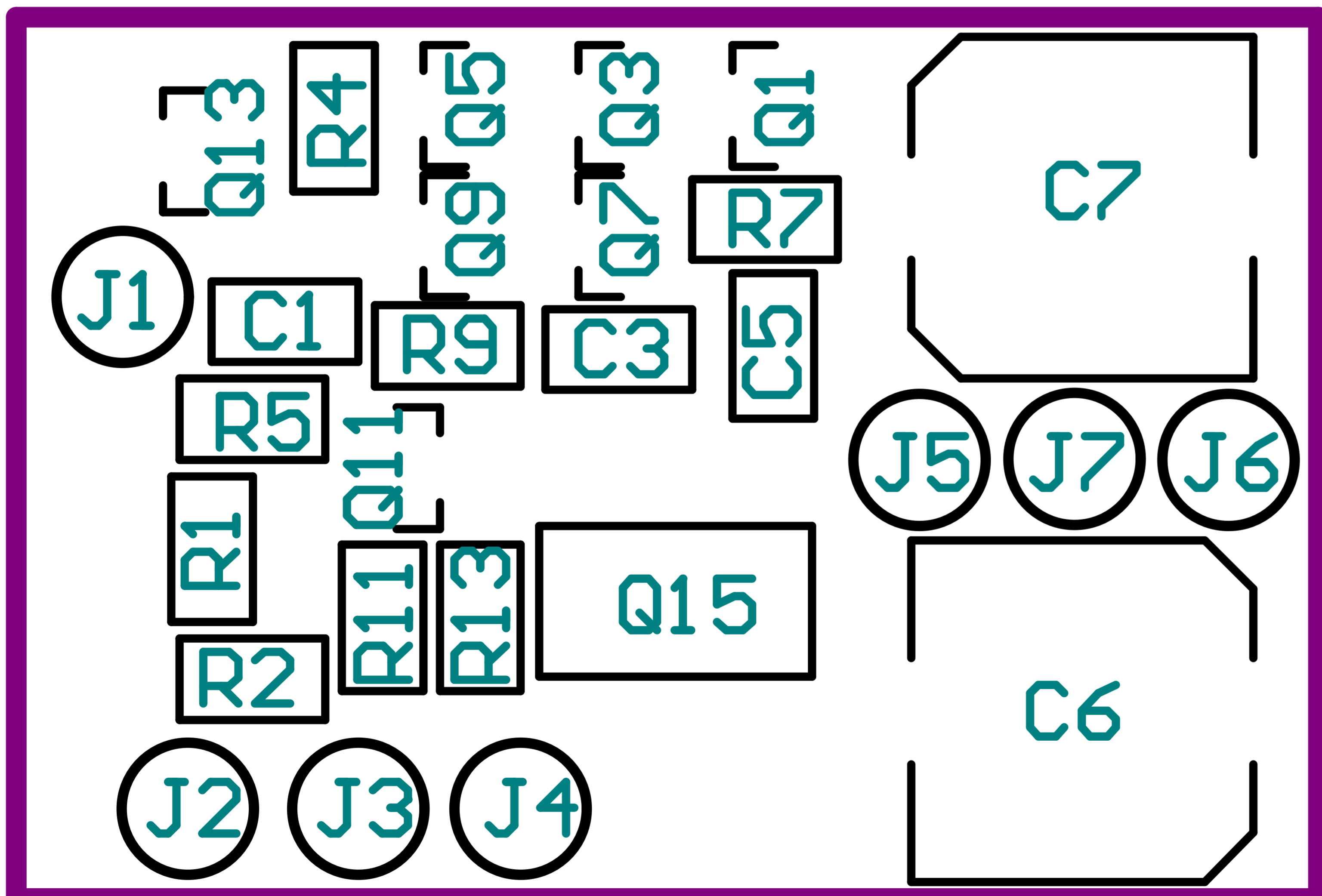

TOP OVERLAY :
PCB BORDER OL
SSB01 Rev.0

ASSEMBLY DRAW

PCB BORDER OF
22B01 Rev.0
BOT OVERLAY

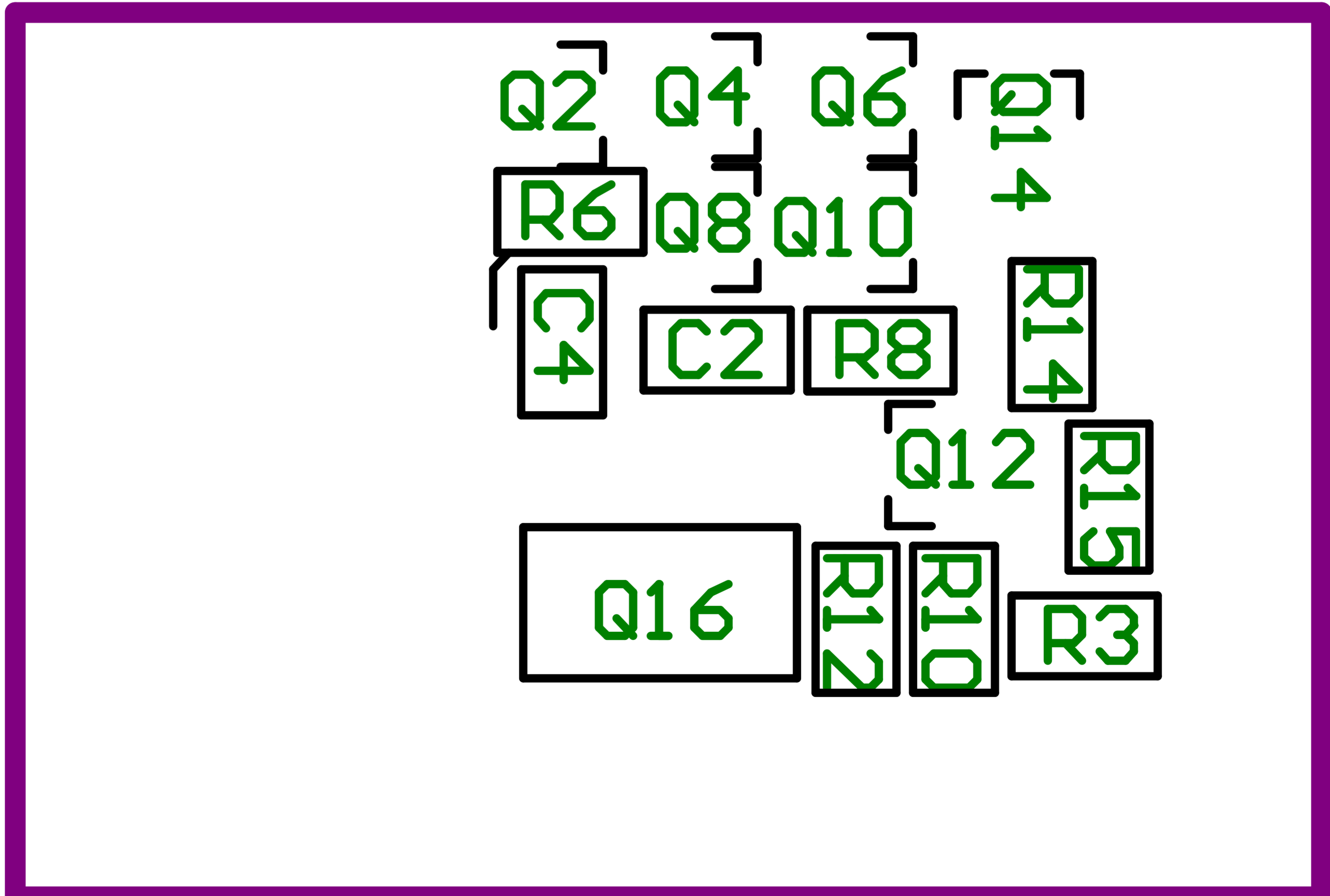

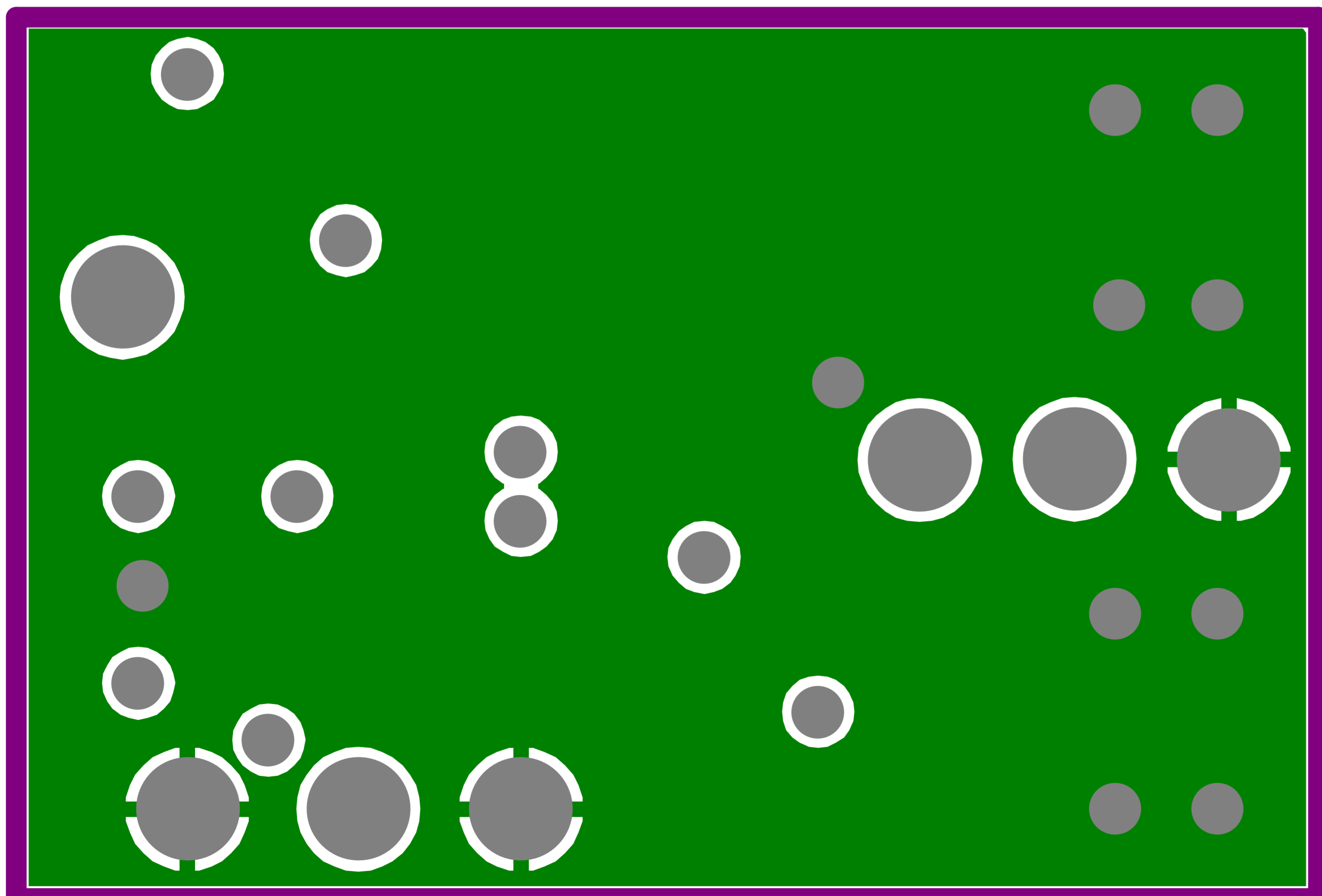

MIDLAYER 2 SS

PCB BORDER OL
SSB01 Rev.0

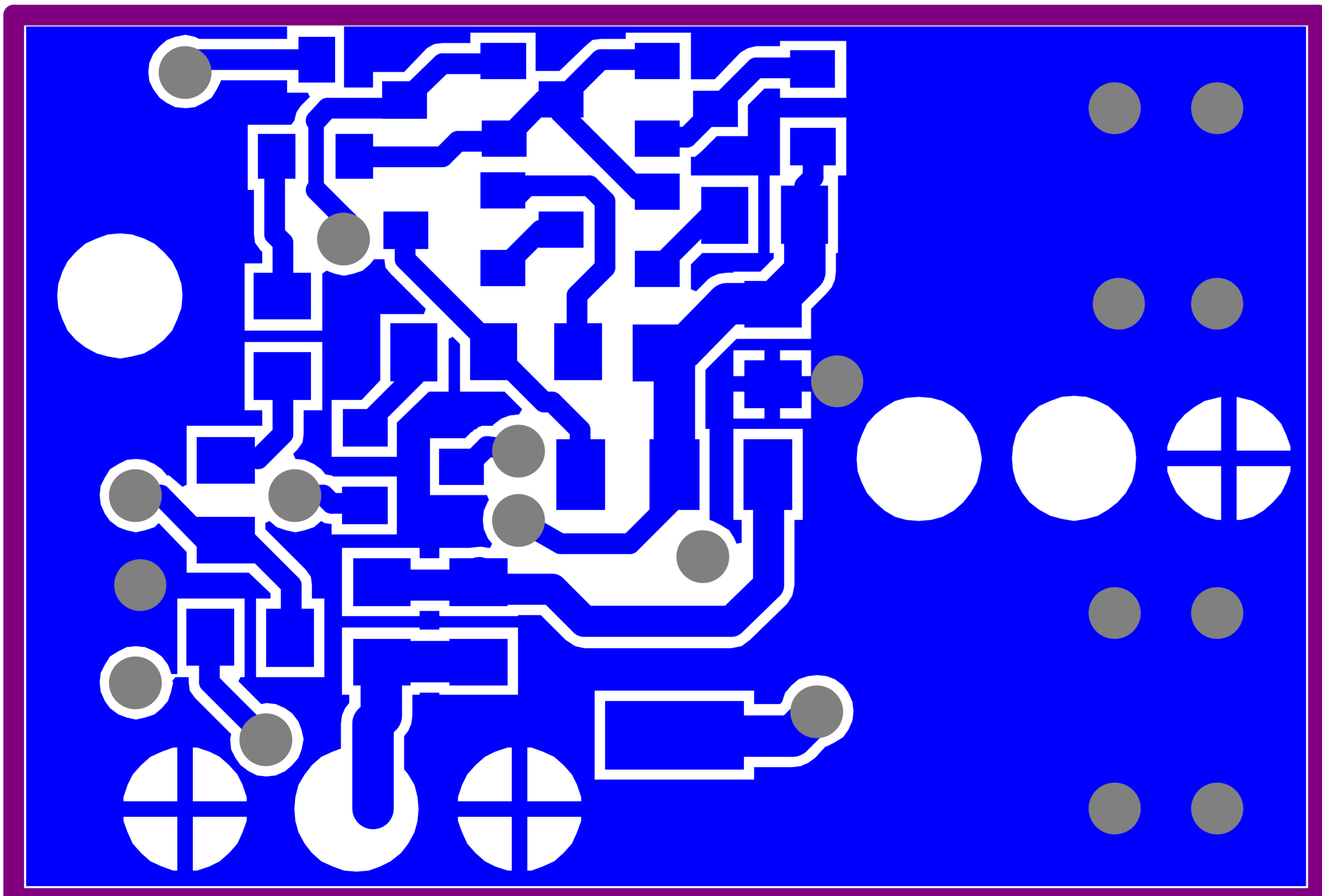

0 BOT LAYER

PCB BORDER OL
SSB01 Rev.0

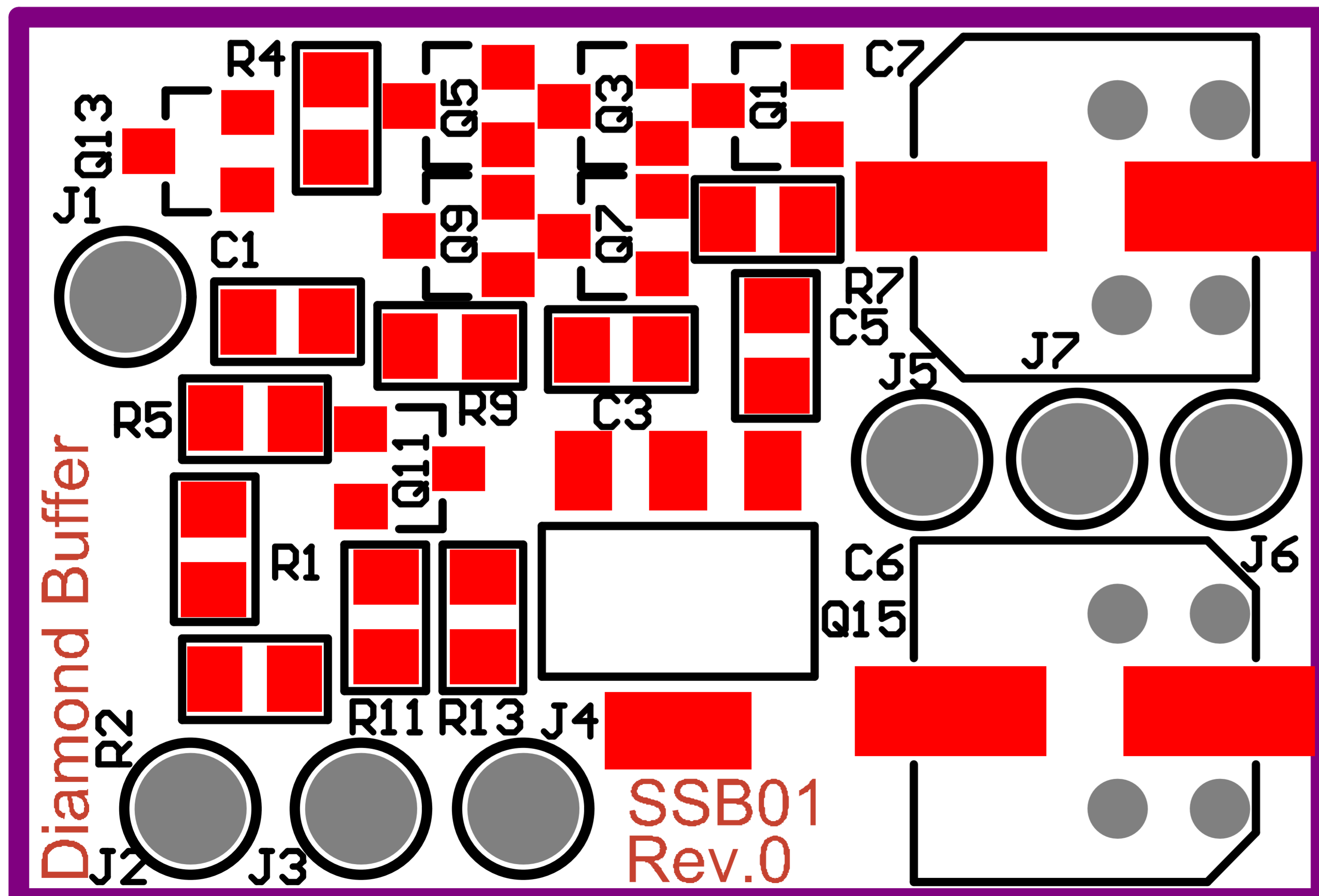

TOP SOLDER SS

TOP OVERLAY SS

PCB BORDER OL

SSB01 Rev.0

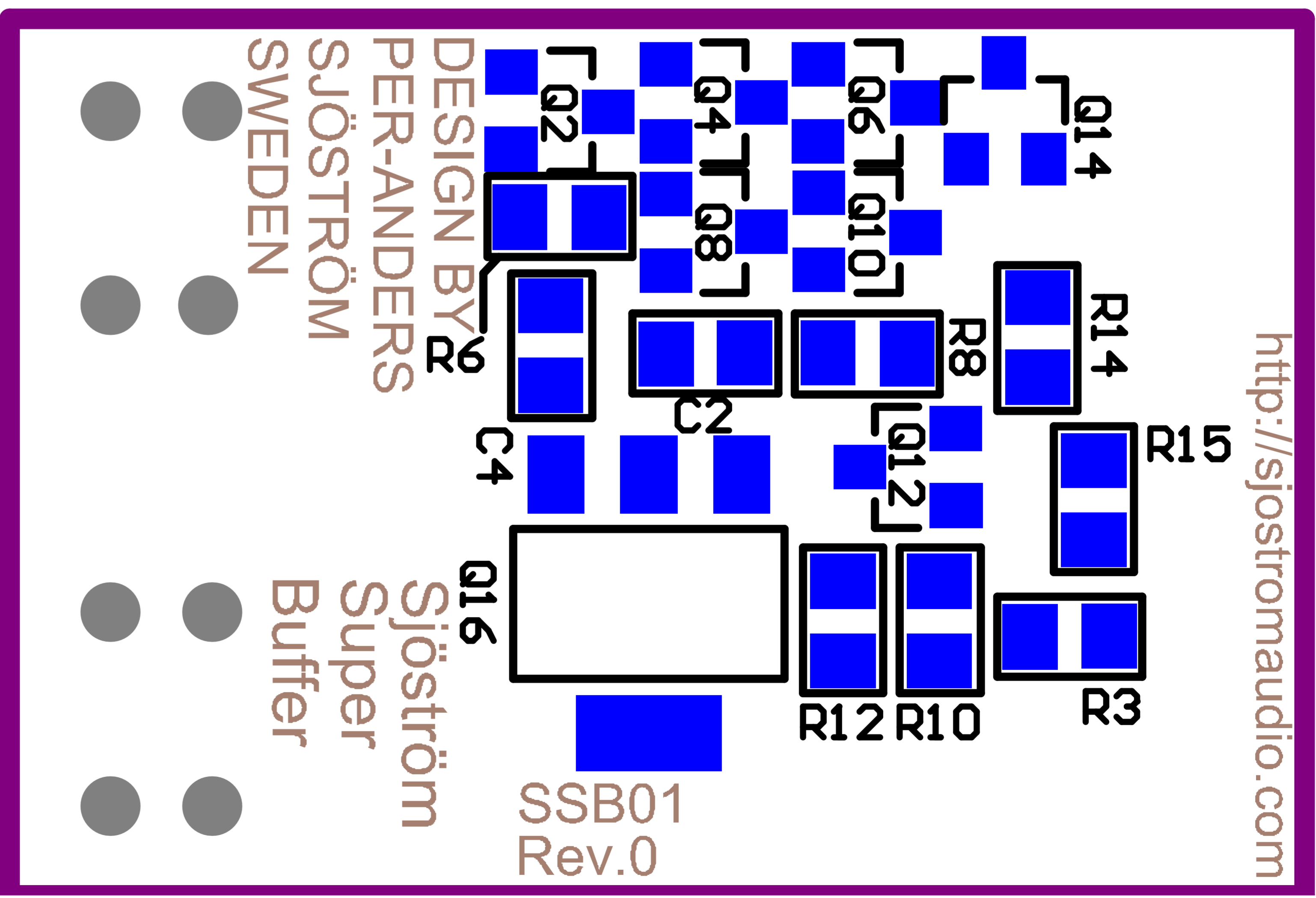

0 BOT SOLDER

PCB BORDER OF
22B01 Rev.0

BOT OVERLAY

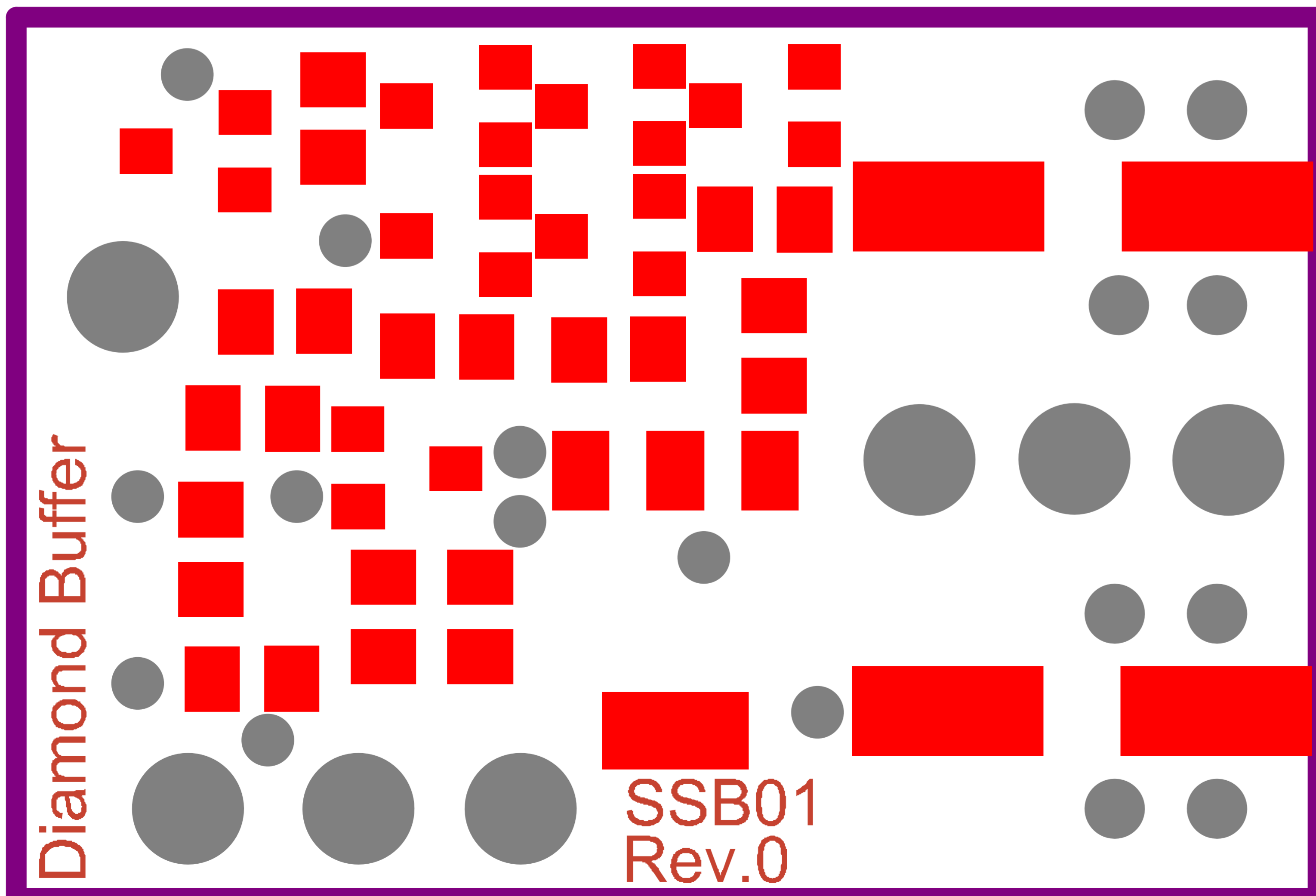

TOP SOLDER SS

PCB BORDER OL
SSB01 Rev.0

<http://sjostromaudio.com>

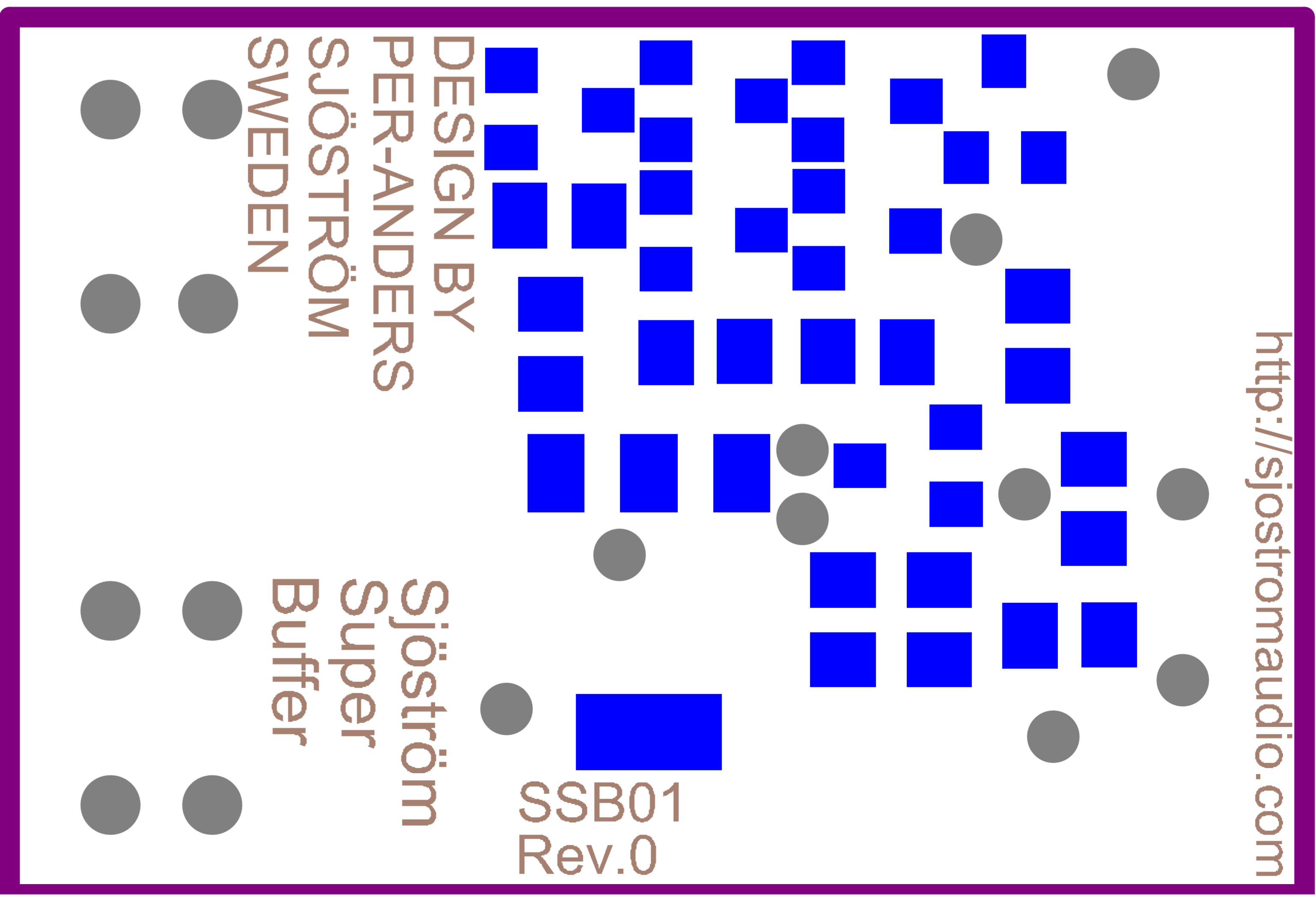

SSB01
Rev.0

DESIGN BY
PER-ANDERS
SJÖSTRÖM
SWEDEN

Sjöström
Super
Buffer

0 BOT SOLDER

22B01 Rev.0
PCB BORDER OR

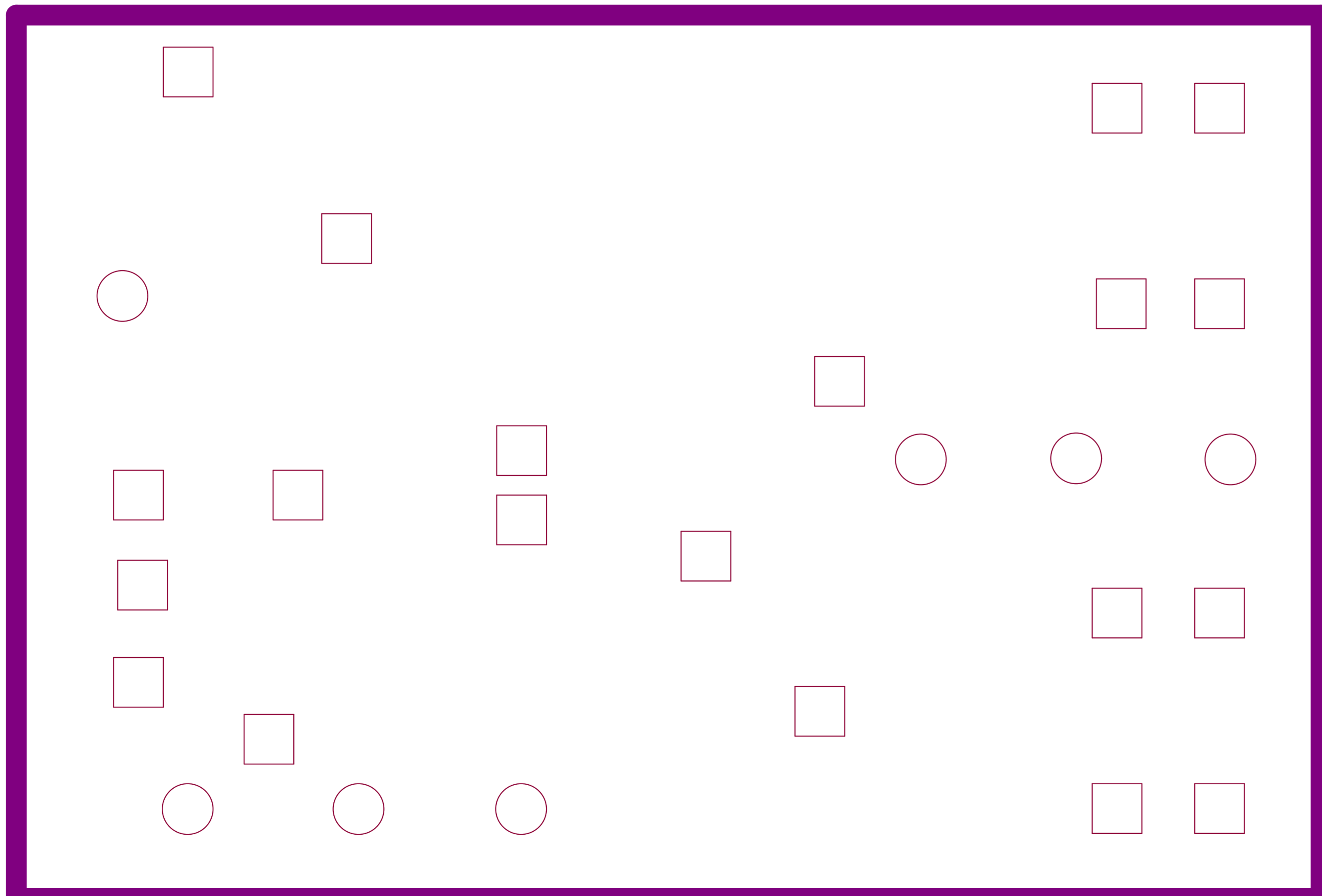

PCB BORDER OL
SSB01 Rev.0